

Article number: 03505017

Description: Fluro Rod end GE 17FO

Measures

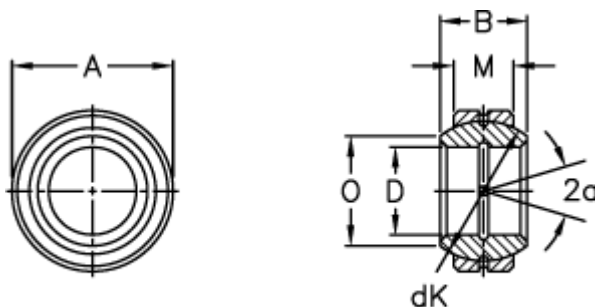

Str. 6–12 uden smørerille

A	= 35 0 -0,011	Tilt angle = 19
B	= 20	Weight = 77
D	= 17 0 -0,008	
dK	= 29	
Dynamic load C (kN)	= 30	
M	= 12	
O	= 21	
Static load C0 (kN)	= 146	